



Wireless Headphones

PBT99 User Manual



Questions?
Need some help?
This manual will help you
enjoy your new product



or visit us at:
www.southern telecom.com
Click on Product Support

Pairing the Headphones

1. Long press the [⏻] button **for 7 seconds**. A tone will be heard and the LED indicator will **flash BLUE and GREEN**.
2. Set your mobile device to search for Bluetooth devices. When your mobile device finds the headphones, select **PBT99** from the list of found devices.
3. After a successful pairing, a tone will be heard and the LED indicator will turn **solid BLUE**.

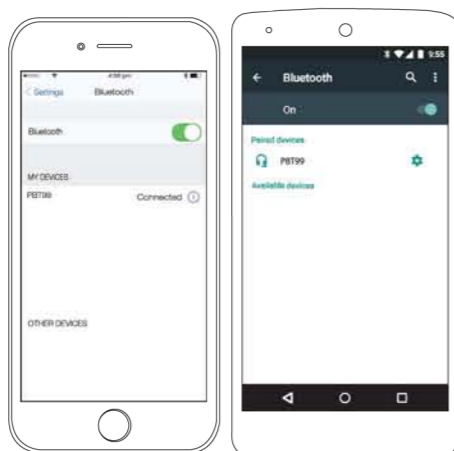

For iOS or Android

- Go to **Settings -> Bluetooth**
(Make sure Bluetooth is turned ON)



The screenshots above are typical of many Bluetooth-enabled devices in the market today and are used to assist in the explanation of the pairing process. Your Bluetooth-enabled device's interface and interaction with the headphones may differ slightly from the illustrations above.

In the Box



Wireless Headphones

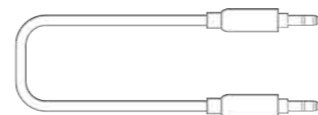

3.5mm Auxiliary Cable

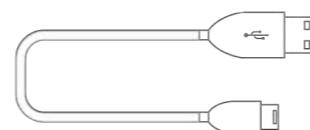

Micro-USB Charging Cable

Using the Headphones



Make sure you charge the headphones for at least 2 to 3 hours before using it for the first time.

Powering ON/OFF

- To turn the **headphones ON**, long press the [⏻] button. A tone will be heard, indicating that the headphones are powered ON.
- To turn the **headphones OFF**, long press the [⏻] button.

Adjusting Volume

- Long press the [⏏] button to **increase volume**. A tone will be heard if you attempt to increase the volume past maximum level.
- Long press the [⏏] button to **decrease volume**.

Phone Calls

- To **answer** an incoming phone call, quick press the [⏻] button.
- To **end** a phone call, quick press the [⏻] button, again.
- To **reject an incoming phone call** and send it straight to voicemail, long press the [⏻] button **for 2 seconds**.

Location of Controls

1. [⏏] Button:
(Long Press) Skip to next track
(Quick Press) Increase volume
2. [⏏] Button:
(Long Press) Skip to previous track
(Quick Press) Decrease volume
3. LED Indicator
4. [⏻] Button:
(Long Press) Power ON/OFF,
Reject phone call
(Quick Press) Play/pause playback,
Answer/end phone calls
5. 5V USB Charging Port
6. Microphone
7. AUX-In Jack

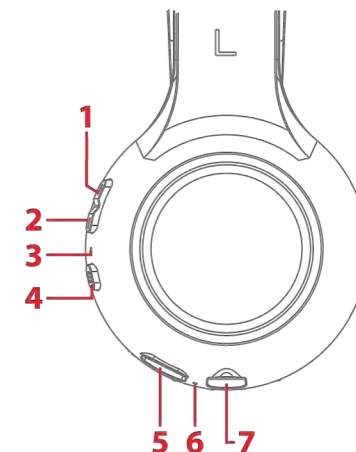

Using the Headphones (cont'd)

Playing Media

To enjoy music on your headphones, make sure you are paired to a Bluetooth-enabled device. Once paired, you can control media playback and volume adjustment with the controls on your paired device or with the headphones.

Playing/Pausing Media

- To **pause media playback**, press the [⏻] button.
- To **resume media playback**, press the [⏻] button, again.

Skipping Tracks

- To skip to the **previous track**, quick press the [⏏] button.
- To skip to the **next track**, quick press the [⏏] button.

Charging the Headphones

To charge the headphones, attach the small connector of the **supplied** micro-USB cable to it. Attach the large connector to a USB port on a computer, USB charging device, or a **5V USB adapter** (not included) and plug into a wall outlet.

The LED indicator will turn **RED** while charging and turn off when charged.

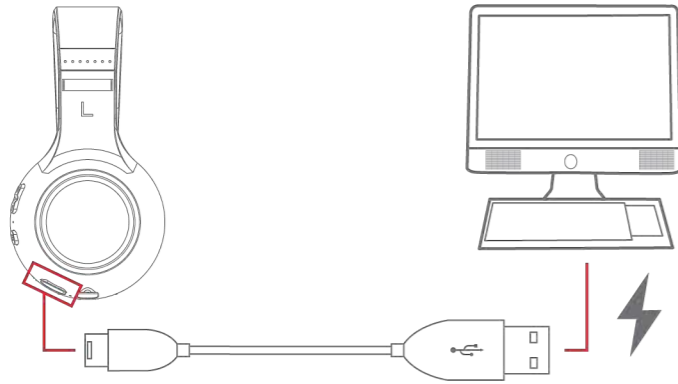

NOTE: A voice will be heard indicating that power is low when the headphones need to be recharged.

Legal Information

READ THIS CAREFULLY AND SAVE FOR FUTURE REFERENCE

This equipment has been tested and found to comply with the limits for a Class B digital device, pursuant to part 15 of the FCC Rules. These limits are designed to provide reasonable protection against harmful interference in a residential installation. This equipment generates, uses and can radiate radio frequency energy and, if not installed and used in accordance with the instructions, may cause harmful interference to radio communications. However, there is no guarantee that interference will not occur in a particular installation. If this equipment does cause harmful interference to radio or television reception, which can be determined by turning the equipment off and on, the user is encouraged to try to correct the interference by one or more of the following measures:

- Reorient or relocate the receiving antenna.
- Increase the separation between the equipment and receiver.
- Connect the equipment into an outlet on a circuit different from that to which the receiver is connected.
- Consult the dealer or an experienced radio/TV technician for help.

Caution: Any changes or modifications to this device not explicitly approved by manufacturer could void your authority to operate this equipment.

This device complies with part 15 of the FCC Rules. Operation is subject to the following two conditions: (1) This device may not cause harmful interference, and (2) this device must accept any interference received, including interference that may cause undesired operation.

The device has been evaluated to meet general RF exposure requirement. The device can be used in portable exposure condition without restriction.

WARNING Li-ion Battery Inside

This product is fitted with a Li-ion battery. Do not damage, open, or dismantle the battery and do not use it in damp and/or corrosive conditions. Use only with compatible chargers. Never dispose of batteries in a fire, and never expose them to high temperatures. Do not expose the product to temperatures exceeding 60°C (140°F).



The crossed-out garbage bin symbol means that you must not dispose of this product together with unsorted household waste.

Rain/Moisture Warning

- Do not expose the unit to extreme temperatures (heat or cold), open flames, humid conditions, or wet conditions.
- Do not submerge in water.
- Do not open this product or attempt to repair the unit yourself should it not be working.

Using with a Wired Device

To use the headphones with a wired device, attach the supplied 3.5mm auxiliary cable to the AUX-In jack on the bottom of the headphones. Attach the other end of the cable to the headphone jack on your media-playing device.

All Bluetooth connections will be disabled, volume adjustment and media playback is controlled through the connected device.

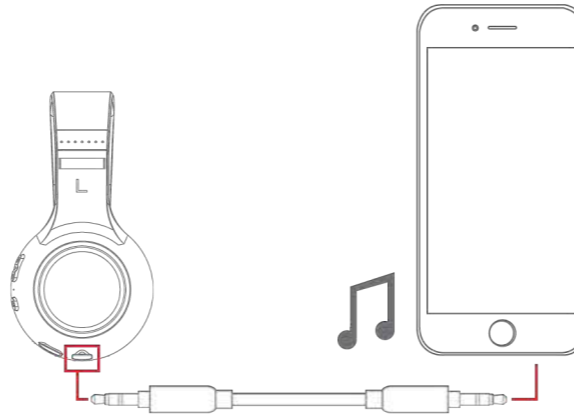

Warranty Information

This product as supplied and distributed new by AIT, Inc. ("AIT") to the original consumer purchaser is warranted by AIT against defects in material and workmanship for a period of one year from your date of purchase ("Warranty"). In the unlikely event that this product is defective, or does not perform properly, you may within one year from your original date of purchase return it to the authorized service center for repair or exchange.

TO OBTAIN WARRANTY SERVICE:

- Go to our website portal to receive an SRO number.
- Provide proof of the date of purchase within the package (dated bill of sale).
- Prepay all shipping costs to the authorized service center, and remember to insure your return.
- Include a return shipping address (no P.O. Boxes), a telephone contact number, and the defective unit within the package.
- Describe the defect or reason you are returning the product.

Your product will be repaired or replaced, at our option, for the same or similar model of equal value if examination by the service center determines this product is defective. Products received damaged as a result of shipping, will require you to file a claim with the carrier.

The shipping address of the authorized service center is:

AIT, Inc.
Customer Service Dept. 36
c/o Southern Telecom
400 Kennedy Drive
Sayreville NJ 08872

IN NO EVENT WILL AIT, ITS MANUFACTURERS, DISTRIBUTORS OR PLR IP HOLDINGS, LLC BE LIABLE FOR ANY INCIDENTAL, DIRECT, INDIRECT, SPECIAL, PUNITIVE OR CONSEQUENTIAL DAMAGES (SUCH AS, BUT NOT LIMITED TO, DAMAGES FOR LOSS OF PROFITS, BUSINESS, SAVINGS, DATA OR RECORDS) RELATED TO THIS PRODUCT. EXCEPT AS STATED HEREIN, NO OTHER WARRANTIES SHALL APPLY.

For further customer service:

- www.southern telecom.com
- Click on **Product Support**



PLR IP Holdings, LLC, its licensees and affiliates, fully support all electronic waste initiatives. As responsible stewards of the environment, and to avoid violating established laws, you should properly dispose of this product in compliance with all applicable regulations, directives or other governances in the area where you reside. Please check with local authorities or the retailer where you purchased this product to determine a location where you can appropriately dispose of the product.

Polaroid, Polaroid & Pixel, Polaroid Color Spectrum, and Polaroid Classic Border Logo are trademarks of PLR, IP Holdings, LLC, used under license.

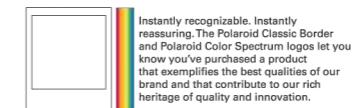

Instantly recognizable. Instantly reassuring. The Polaroid Classic Border and Polaroid Color Spectrum logos let you know you've purchased a product that exemplifies the best qualities of our brand and that contribute to our rich heritage of quality and innovation.